

APart

MANUAL

 МУЗЦЕНТР
МУЗЫКАЛЬНОЕ ОБОРУДОВАНИЕ

<https://muzcentre.ru/>



OV08P

Introduction

Thank you for buying the APart OVO8P active 2-way speaker. We have put great care and effort in the design in order to guarantee the highest possible sound quality. Please read this manual before using the product. This manual provides you with the information necessary to ensure a seamless installation and the best possible sound quality. A power amplifier has already been incorporated inside the speaker cabinet. The speaker is available in black or white and is equipped with a sturdy metal speaker bracket for easy installation at various possible angles. The speaker has balanced line inputs on XLR and unbalanced line inputs on RCA connectors. The inputs can be linked in order to daisy chain multiple units.

For indoor use only! This speaker is not magnetically shielded.

Safety precautions

- Please check the packing for any kind of damage upon reception of the goods. If the packing is damaged, please contact your dealer before opening it.
- !!!! Danger !!!! Exposure to high sound pressure levels may cause permanent hearing loss. Hearing loss induced by exposure to high sound pressure levels will vary from individual to individual, but nearly everyone will lose some hearing when exposed for a sufficient amount of time. Therefore it is recommended that all persons exposed to equipment capable of producing high sound pressure levels, such as this unit, wear sufficient ear protection while installing or operating this unit.
- Read all documentation before operating your equipment.
- Keep all documentation for future reference.
- Keep the carton and packing material, even if the equipment has arrived in good condition.
- Should you ever need to send the unit back, use only the original factory packing.

- Do not spill water or other liquids on or into the unit.
- Make sure power outlets conform to the power requirements listed on the back of the unit.
- Do not use the unit if the electrical power cord is frayed or broken.
- Do not connect the inputs/outputs of amplifiers or consoles to any other voltage source, such as batteries, mains sources or power supplies, regardless of whether the amplifier or console is turned on or off.
- Power down and disconnect units from mains voltage before making connections.
- Do not use the unit near stoves, heat registers, radiators, or other heat producing devices.
- Do not remove the cover. Removing the cover will expose you to potentially dangerous voltages.
- Do not drive the inputs with a signal level higher than that required to drive equipment to full output.
- Do not run the output of any amplifier back into another input.
- In case of malfunction, this device should be serviced by qualified service personnel only. If not serviced by qualified personnel, warranty may be void.
- For indoor use only! Do not expose the speaker to high humidity levels and/or high ambient temperatures.
- Avoid exposure to direct sunlight. Long term exposure to high UV radiation may cause color changes over time.

Features

- Built-in power amplifier.
- 60 Watts output power.
- Ideally suited for AV monitor applications and background music applications requiring modest sound pressure levels.
- 2-way bass reflex speaker with 8 inch woofer and 1 inch soft dome tweeter.
- Molded ABS cabinet.
- Painted metal speaker brackets with various possible installing angles.
- All connections and controls are positioned at the backside of the speaker.
- Easy installation, even in room corners, thanks to flexible mounting brackets (included).
- Can also be placed free-standing on a desk or on any flat and solid surface.
- Separate bass and treble tone controls.
- Volume control.
- RCA/cinch input for unbalanced line level signals, with link.
- Male and female linked XLR connectors for balanced line level signals.
- Excellent musical quality, crystal clear voice reproduction.
- Power LED and accurate clip indicator LED.
- Improved thermal design.
- Indoor use only.
- Do not use this speaker in sound systems requiring constant high sound pressure levels, such as in pubs, bars...

Speaker installation

The speaker is equipped with a custom made painted metal bracket for easy wall mounting. This bracket allows the speaker to rotate vertically as well as horizontally, so the speaker can be installed at various possible angles. Be sure to use screws and wall plugs adapted to the material of the wall. A special plastic wedge is included to enable you to mount the speakers parallel to the wall. Without the wedge, the speakers can be mounted under various downward vertical angles.

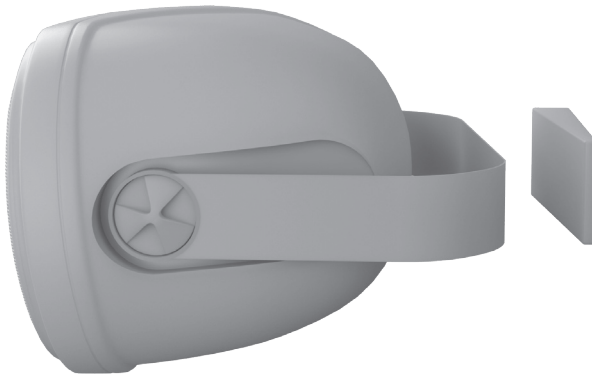

horizontal use of the speaker



vertical use of the speaker



increased inclination

Rear panel layout: connections and sound settings.

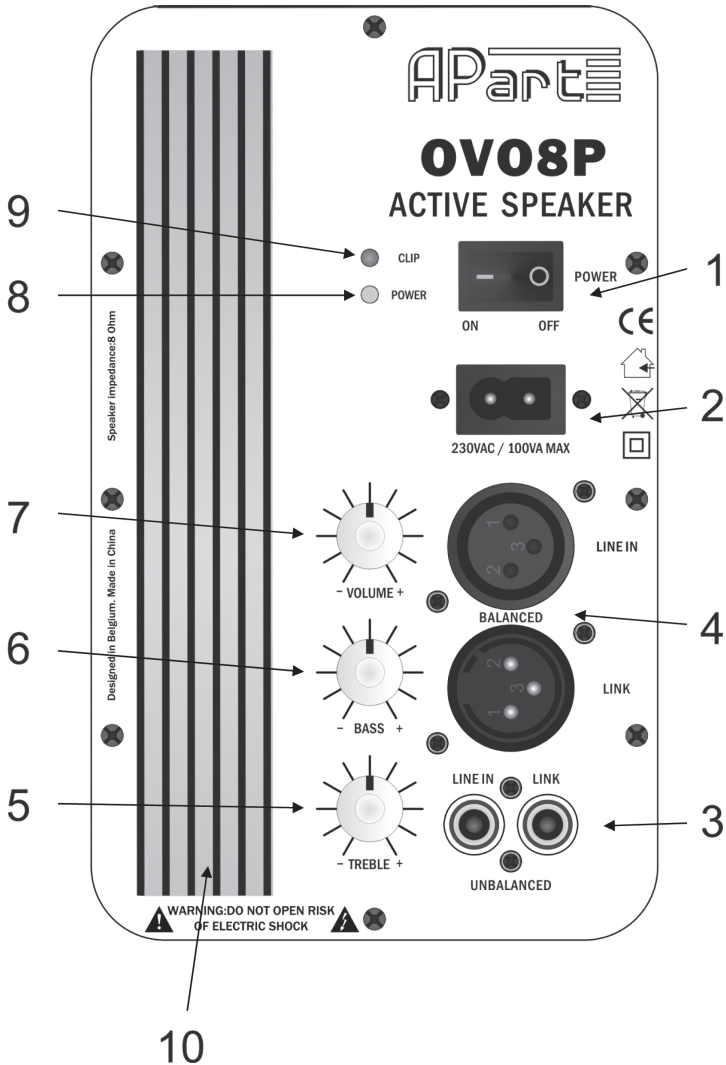

1. Power on/off switch: flip the switch to power the speaker on or off. Always power off the unit when not in use.
2. AC inlet socket: connect the included power cord here. AC mains voltage is 230VAC \pm 10%/50-60 Hz. The mains fuse is located inside the cabinet and must be replaced only with an identical fuse. If the fuse blows up regularly, have your unit serviced by a qualified service technician.
3. RCA input: 2 identical RCA connectors for unbalanced line level signals. The line-in and link connector are internally connected in parallel, allowing you to link the signal through to one or more active speakers.
4. XLR input: male and female XLR connectors for balanced line level signals. The line-in and link connectors are internally connected in parallel, allowing you to link the signal through to one or more active speakers.
5. Treble tone control: Center position = neutral. To the left = less treble, to the right = more treble.
6. Bass tone control: Center position = neutral. To the left = less bass, to the right = more bass.
7. Volume: turn clockwise to increase the volume. When turned counterclockwise to the limit, the audio signal present at the inputs is muted.
8. Power LED: lights up green when the power cord is connected to a working AC outlet and the power switch is turned to the on position.
9. Clip LED: this red LED lights up when the internal power amplifier is overloaded. Reduce the volume so that the clip LED does not light up during use. When the sound is distorted, the signal level at the inputs is too high. Reduce the output from your audio source (pre-amplifier) in such cases.
10. Heat sink: keep the heat sink free from dust, do not cover the heat sink and ensure sufficient airflow in this area.

Specifications

Input sensitivity/impedance	Unbalanced RCA: 305 mV, 10 kOhm Balanced XLR: 1200 mV, 10 kOhm
Tone control	Bass: +/- 12 dB at 80 Hz Treble: +/- 12 dB at 12 KHz
System performance	60 watts RMS in 8 ohms
Speaker impedance	8 ohms
Frequency range	40 Hz - 20.000 Hz
THD	< 0.02 % at full power -6 dB
S/N ratio	> 105 dB
AC supply voltage	230 VAC +/- 10%, 50-60 Hz
Max power consumption	100 VA
Idle power consumption	15 VA
System setup	2-way bass-reflex speaker 8 inch coated paper woofer 1 inch soft dome tweeter ABS molded cabinet
Dimensions H x W x D	358 x 244 x 250 mm
Weight (per speaker)	8 kg
Packing dimensions	715 x 405 x 280 mm
Shipping weight (per pair)	8.350 kg
Included accessories	speaker bracket, manual, power cord

Polar diagram 1000 Hz

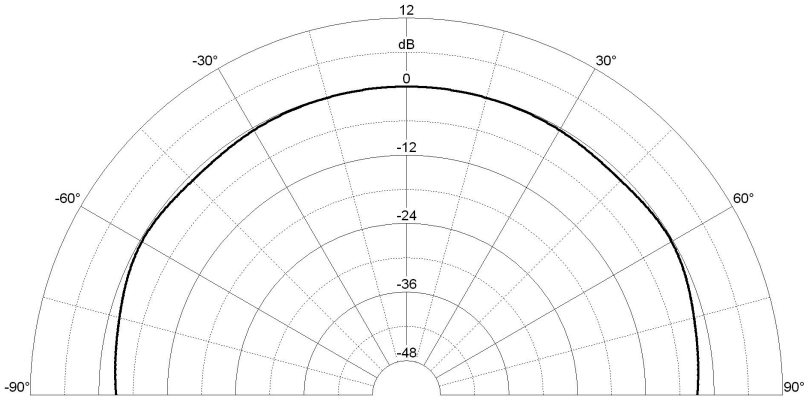

Polar diagram 4000 Hz

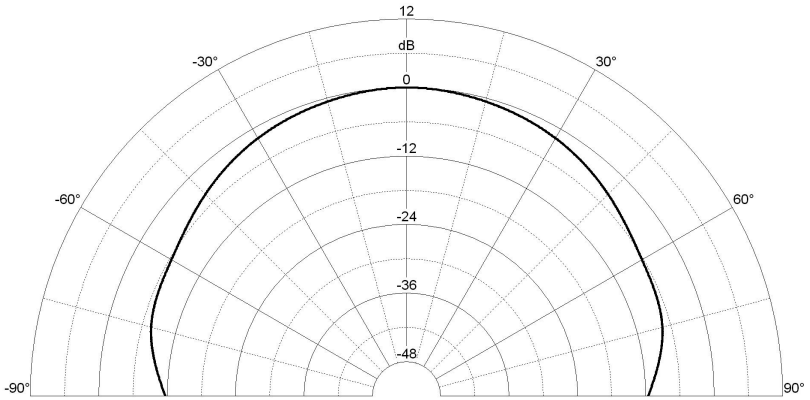

Polar diagram 8000 Hz

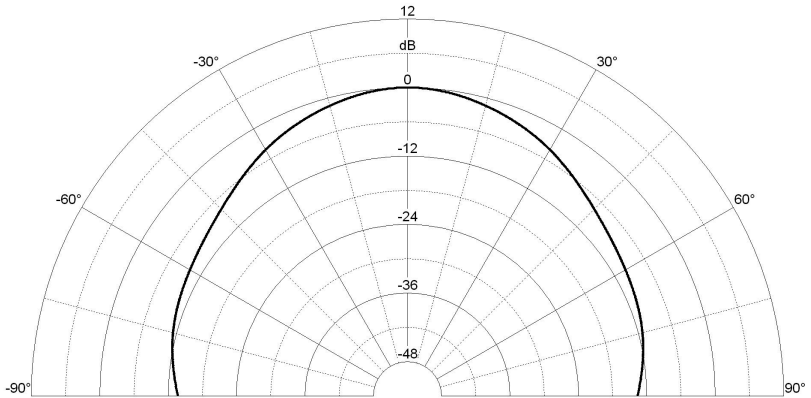

Technical drawing with measurements

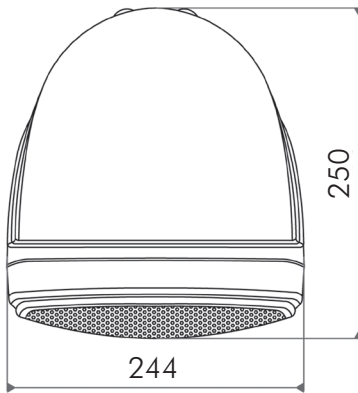
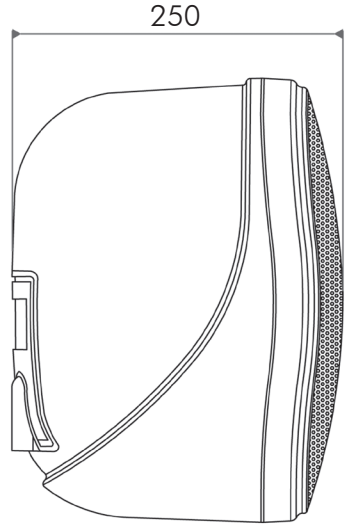
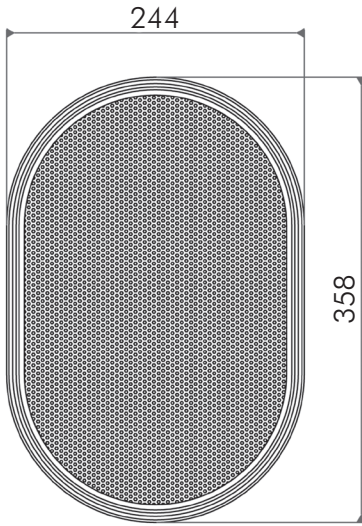

Warranty info

APart-Audio warrants this product to be free of defects in material and workmanship for a period of one year for parts and for a period of one year for labor from the date of original end-user purchase. This warranty is valid only for the original end-user and cannot be transferred.

During the warranty period APart-Audio or one of its authorized service partners shall either repair or replace any product, free of charge, that proves to be defective on inspection by APart-Audio or its authorized service representative.

This warranty does not include, damages or product faults due to abuse, misuse or faulty installation.

Notes

The line level signals present on the RCA and XLR connectors, are internally mixed together. A balanced signal on the XLR's will however not be available on the unbalanced RCA's and vice versa.

Tips for trouble-free use: Always respect the basic power on sequence rules valid for most audio applications. Amplifiers and/or powered speakers such as this product will be powered on only after all the other devices in the audio chain have been powered up! Always power off amplifiers and/or powered speakers first and do not leave them powered on unnecessary!

Balanced XLR connectors:



Male (link)



Female (line in)

- 1 = GND (audio ground)
- 2 = hot (+ line level signal, in phase)
- 3 = cold (- line level signal, opposite phase)

For unbalanced signals on XLR: pin 1 must be connected to pin 3 and becomes the ground for the unbalanced signal. Pin 2 is the positive signal pin. Alternatively, you can use the dedicated unbalanced RCA input.

APart III

ANY SUGGESTION?

***They are well appreciated and eventually rewarded!
Send your ideas or suggestions to***

suggestions@apart-audio.com

Company names, product names, and names of formats etc. are the trademarks or registered trademarks of their respective owners.

© 2012 APart-Audio specifications subject to change without notice.

developed by

***Audioprof nv
Industriepark Brechtsebaan 8 bus 1
2900 Schoten
Belgium***

